



Features

1. Current transfer ratio.
(CTR: MIN. 60% at $I_F = \pm 1\text{mA}$ $V_{CE} = 5\text{V}$)
2. High isolation voltage between input and output.
(Viso: 5000V_{RMS})
3. Compact dual-in-line package.
4. AC input.
5. Available package types: DIP(shown)/ SMD/ H (Page: 138).

Part Numbering System: Page 2. **Part Marking System:** Page 4.

Applications

1. Programmable controller applications for low input photo couplers and high V_{CEO} photo couplers.
2. Telephone sets, telephone exchangers.
3. System appliances, limit switches, sensors, thermostats transducers etc.
4. Signal transmission between circuits of different potentials and impedances.

Classification table of current transfer ratio is shown below.

RANK MARK	CTR(%)
E	60 TO 600

Outside Dimension: Unit (mm)

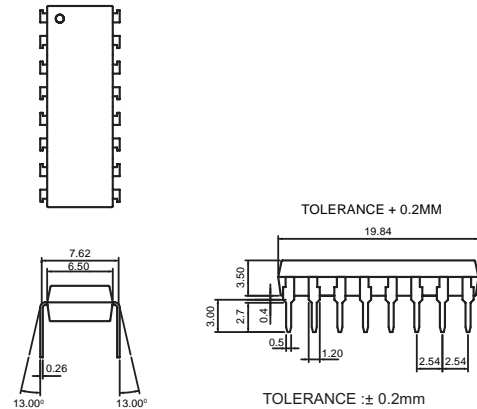

Schematic: Top View

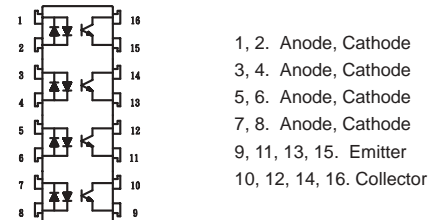

Absolute Maximum Ratings

($T_a = 25^\circ\text{C}$)

Parameter	Symbol	Rating	Unit
Input	Forward current	± 50	mA
	Peak forward current	± 1	A
	Power dissipation	70	mW
Output	Collector-emitter voltage	60	V
	Emitter-collector voltage	6	V
	Collector current	50	mA
	Collector power dissipation	150	mW
	Total power dissipation	200	mW
Isolation voltage 1 minute	Viso	5000	V _{rms}
Operating temperature	Topr	-30 to +100	$^\circ\text{C}$
Storage temperature	Tstg	-55 to +125	$^\circ\text{C}$
Soldering temperature 10 second	Tsol	260	$^\circ\text{C}$

Electro-optical Characteristics

($T_a = 25^\circ\text{C}$)

Parameter	Symbol	Conditions	MIN.	TYP.	MAX.	Unit
Input	Forward voltage	$I_F = \pm 20\text{mA}$	—	1.2	1.4	V
	Peak forward voltage	$I_{FM} = \pm 0.5\text{A}$	—	—	3.5	V
	Terminal capacitance	$V=0, f=1\text{kHz}$	—	30	—	pF
Output	Collector dark current	$V_{CE} = 20\text{V}, I_F = 0$	—	—	0.1	μA
Transfer characteristics	Current transfer ratio	$I_F = \pm 1\text{mA}, V_{CE} = 5\text{V}$	60	—	600	%
	Collector-emitter saturation voltage	$I_F = \pm 20\text{mA}, I_C = 1\text{mA}$	—	0.1	0.3	V
	Isolation resistance	DC500V	5×10^{10}	10^{11}	—	ohm
	Floating capacitance	$V=0, f=1\text{MHz}$	—	0.6	1.0	pF
	Cut-off frequency	$V_{CC} = 5\text{V}, I_C = 2\text{mA}, R_L = 100\text{ohm}$	—	80	—	kHz
	Response time (Rise)	$V_{CE} = 2\text{V}, I_C = 2\text{mA}, R_L = 100\text{ohm}$	—	5	20	μs
	Response time (Fall)		—	4	20	μs



Fig.1 Current Transfer Ratio vs. Forward Current

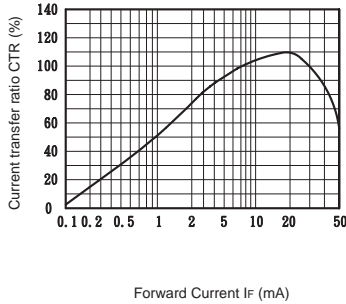

Fig.2 Collector Power Dissipation vs. Ambient Temperature

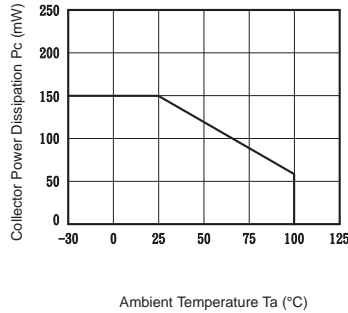

Fig.3 Collector Dark Current vs. Ambient Temperature

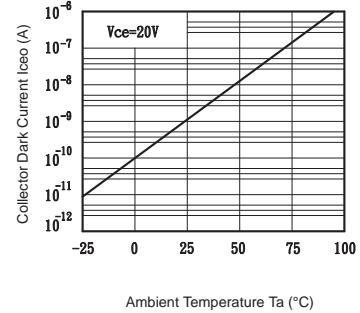

Fig.4 Forward Current vs. Ambient Temperature

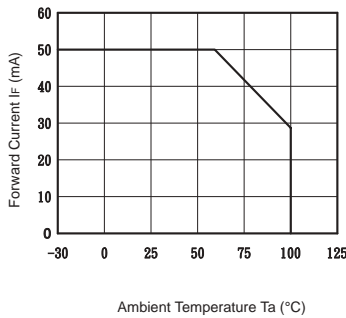

Fig.5 Forward Current vs. Forward Voltage

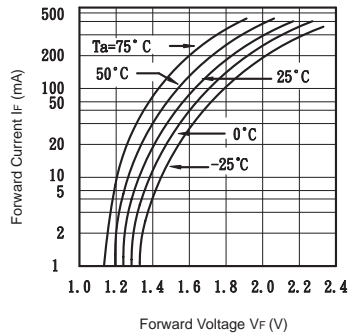

Fig.6 Collector Current vs. Collector-emitter Voltage

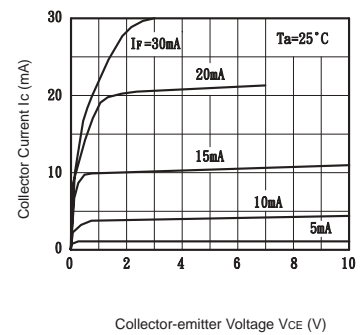

Fig.7 Relative Current Transfer Ratio vs. Ambient Temperature

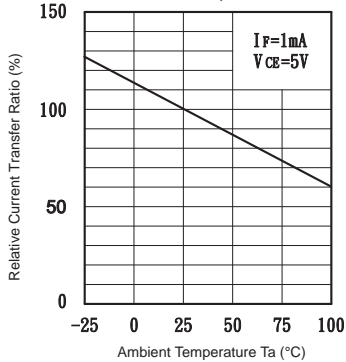

Fig.8 Collector-emitter Saturation Voltage vs. Ambient Temperature

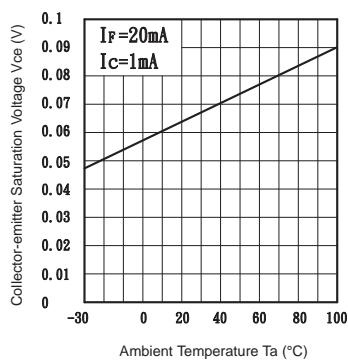

Fig.9 Collector-emitter Saturation Voltage vs. Forward Current

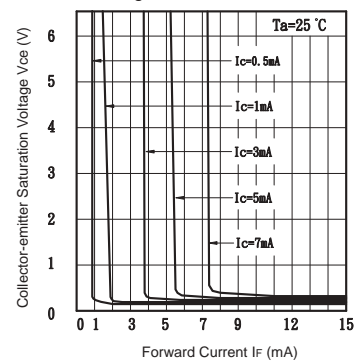

Fig.10 Response Time vs. Load Resistance

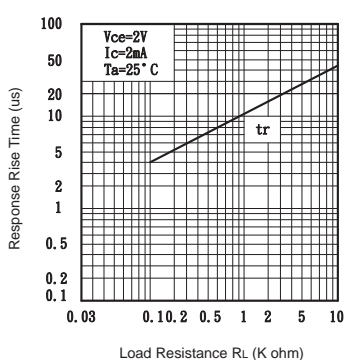

Fig.11 Response Time vs. Load Resistance

